

### ► Specification

Model	Size(unit:mm)	Voltage	Current	Holding Force	Lock Signal	Door Signal	Door
AX-M620L	250Lx48.5Wx25H	12/24VDC	12V/500mA 24V/250mA	280kg(600Lbs)	Yes	No	Single Door
AX-M620X2L	500Lx48.5Wx25H	12/24VDC	12V/500mAx2 24V/250mAx2	280kgx2(600Lbsx2)	Yes	No	Double Door
AX-M620LDS	250Lx48.5Wx25H	12/24VDC	12V/500mA 24V/250mA	280kg(600Lbs)	Yes	NO(B),NC(R) COM(Y)	Single Door

### ► Diagram(unit:mm)

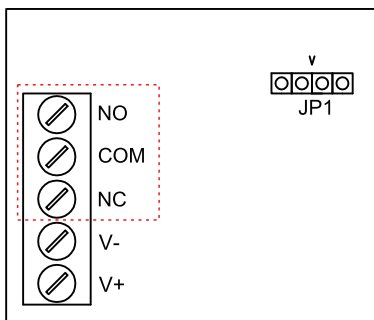

Door Sensor	
Red	NC
Yellow	COM
Black	NO

Equipped with door signal&lock signal magnetic lock will be equipped with NO/NO/COM lock status sensor.

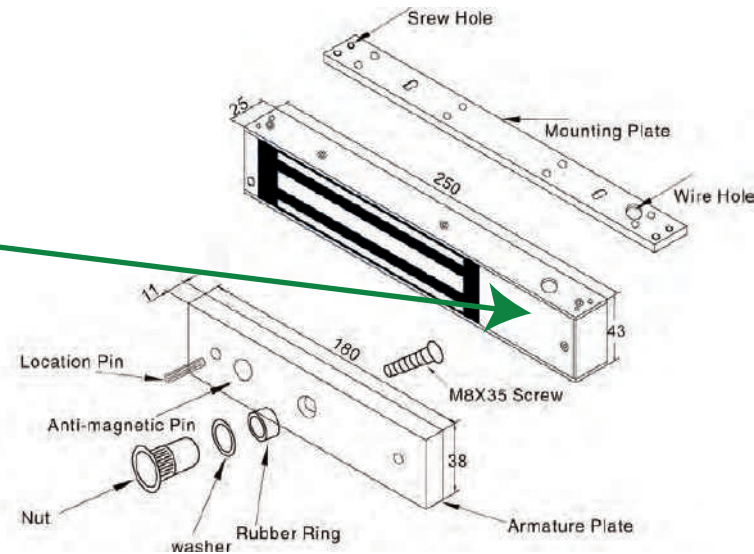

### Cautions:

- The screw of armature plate should not be fixed too tight. Proper elasticity should be guaranteed for the rubber ring so that the armature plate can adjust itself to the appropriate position.
- Check the jumper's position before connecting. Figure out it represents 12VDC or 24VDC.

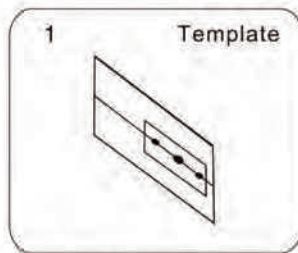
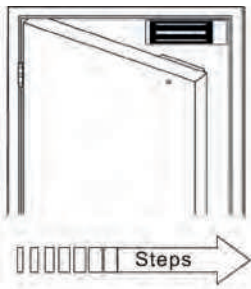

1 Template  
Fold the plate to 90° .

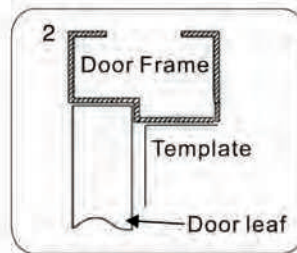

2 Door Frame  
Template  
Door leaf  
Close the door first, then place the upper side of template on door frame, while adjust the left side next to the door leaf.

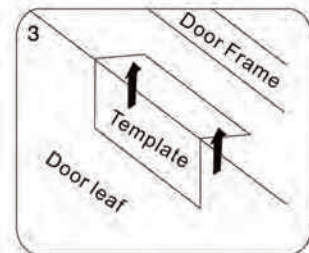

3 Door Frame  
Template  
Door leaf  
Mark screw positions of armature plate and magnetic lock on door leaf and door frame respectively.

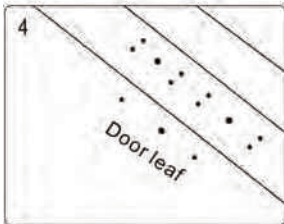

4 Door leaf  
Drill holes based on the marked positions.

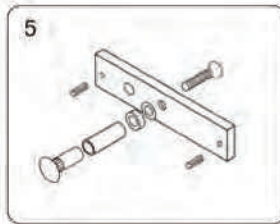

5  
Make a combination based on the picture.

Hollow Metal Door    Wooden Door    Metal Surface Door

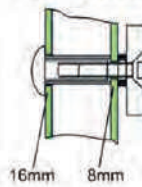

Drill a hole  
Inside: Diameter is 8mm  
Outside: Diameter is 16mm

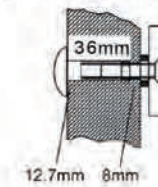

Drill a hole  
Inside: Diameter is 8mm  
Outside: Diameter is 12.7mm

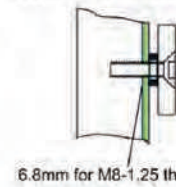

Inside: Drill a hole diameter is 8mm folding the plastic straight pin

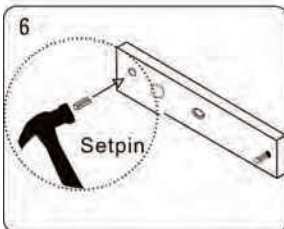

6 Setpin  
Strike the pin into the armature plate slightly (to avoid movement).

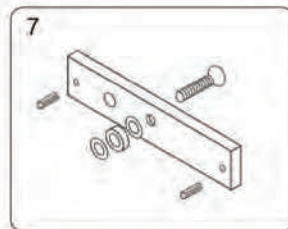

7  
Make a combination based on the picture (add washer accordingly). The rubber ring must be added.

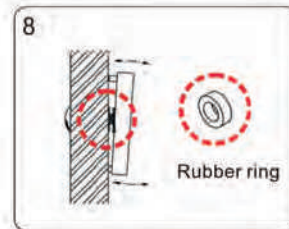

8 Rubber ring  
Place the rubber ring between armature plate and door leaf.

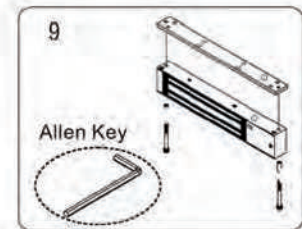

9 Allen Key  
Use Allen key to remove the mounting plate from lock body.

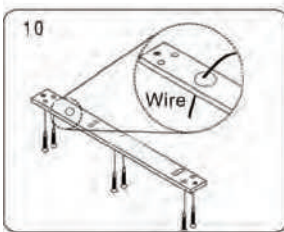

10 Wire  
Fix the mounting plate on the door frame according to the holes drilled earlier.

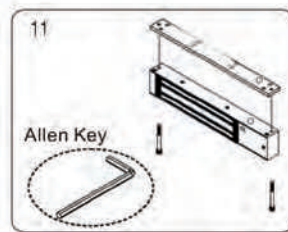

11 Allen Key  
Use Allen key to screw the lock body on the mounting plate.

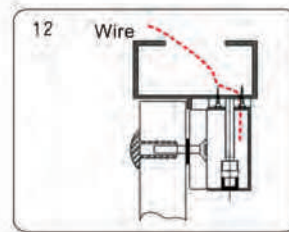

12 Wire  
Close the door to test holding force. The angle between armature plate and magnetic lock can be adjusted by adding or reducing washers.

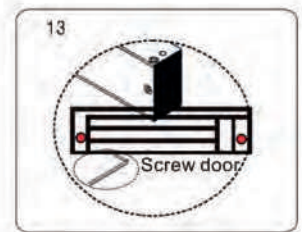

13 Screw door  
After all the appropriate procedures, the holding force can be maximized. Finally, fix the tamper screw.

Different brackets are available according to different types of doors. For example, narrow door , frameless glass door and inward opening door.

**L Bracket-For outward opening door**

When the door frame thickness is less than 42mm, L bracket is needed.

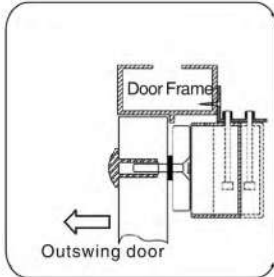

**ZL Bracket-For inward opening door**

For inward opening door, ZL bracket is needed.

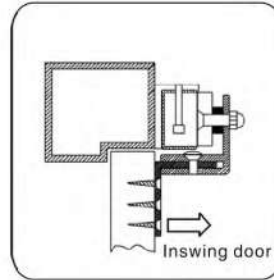

**U Bracket**

For the frameless glass door. U bracket is needed.

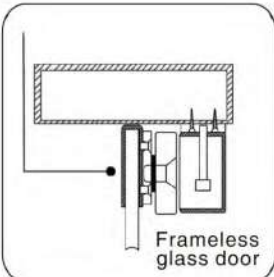

**I Bracket for armature plate**

When the door frame is too thick, I bracket is needed.

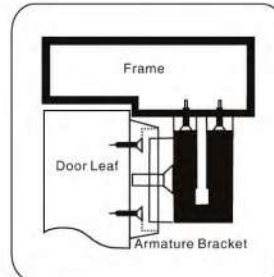

► Installation Instruction



Demonstration of I Bracket Installation

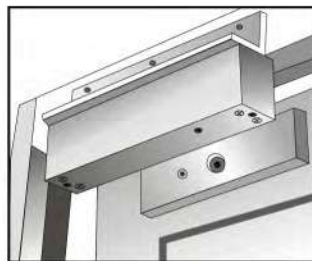

Demonstration of L Bracket Installation

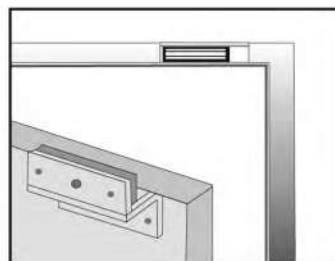

Demonstration of ZL Bracket Installation

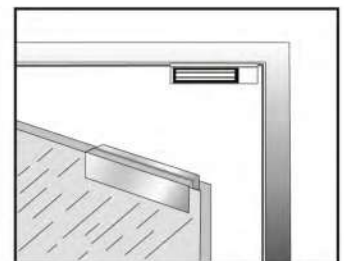

Demonstration of UL Bracket Installation

### A. 12VDC Input:

Required power 0.5Amp(Minimum).  
 Connect the positive(+)lead from a 12VDC power source to V +.  
 Connect the ground(-)lead from a 12VDC power source to V -.  
 Check jumper for 12 VDC operation.

### B. 24VDC Input:

Required power 0.25Amp(Minimum).  
 Connect the positive(+)lead from a 24VDC power source to V +.  
 Connect the ground(-)lead from a 24VDC power source to V -.  
 Check jumper for 24 VDC operation.

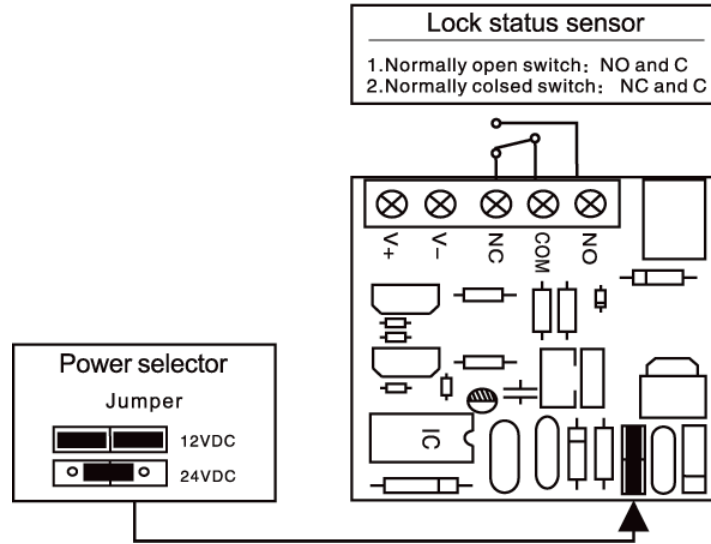

### ► Wire Connection

